

For Jo. Co. Public works use only
Permit No.



Entrance Permit Application

Name (Owner): _____ Phone No. _____

Mailing Address (Owner): _____

Contact Person _____ Phone No. _____

E-Mail Address: _____

Entrance address or location: _____

Type of Entrance:	<input type="checkbox"/> Residential	<input type="checkbox"/> Farm	<input type="checkbox"/> Commercial/Industrial
Side of Road:	_____	Proposed Driveway Width	_____
Proposed Entrance Surfacing:	<input type="checkbox"/> Gravel	<input type="checkbox"/> Asphalt	<input type="checkbox"/> Concrete
Proposed Culvert Material:	<input type="checkbox"/> Aluminized Corrugated Metal	<input type="checkbox"/> Reinforced Concrete Pipe	(Min. Size=15")
Comments:	_____		

I hereby request permission to construct an entrance onto a county road at the above described location. If this application is approved, I agree to construct the entrance in accordance with county specifications and requirements. I agree to hold **Johnson County harmless from and against any and all damages, cost, charges, or liabilities arising directly or indirectly out of the performance of work under terms of this application.** Attached is a \$75 check payable to Johnson County Public Works.

- I Agree That I will be responsible for maintenance of the entrance, including the part that extends into the right-of-way.
- I Agree That Traffic Control, if needed, shall be according to the Manual of Uniform Traffic Control Devices
- I Agree That Mailboxes, if installed, shall be according to the attached Mailbox Guidelines
- I Agree to contact this office prior to covering/backfilling pipe and prior to placing final surface.

(Owner/Applicant)

Date

Do not write below - For office use only

CARNP Type: _____	Sight Distance Adequate	<input type="checkbox"/> Yes
Culvert Required:	<input type="checkbox"/> Yes <input type="checkbox"/> No	Culvert Size Required: _____
Comments:	_____	

The Owner / Applicant is hereby granted permission to construct an entrance at the above described location.		
By:	Date:	

Final Inspection (given prior to final occupancy inspection by Building Codes)

Date: _____	Approved By: _____
Comments: _____	



Driveway Entrance Requirements And General Information

Permit Required:

Johnson County requires that a property owner obtain an Entrance Permit from the Public Works Department prior to installing a new driveway entrance or removal and replacement of an existing entrance. Temporary construction entrances also require a permit. This work cannot be performed on County right-of-way without an approved permit.

Obtaining an Application for a Permit: Entrance Permit Applications can be obtained from Johnson County Public Works located at 1800 West 56 Highway, Olathe, Kansas, 66061. The permit applications are also available on the Johnson County Public Works web site or can be obtained by fax by calling (913) 715-8300.

Filing the Application: After providing the necessary information, the applicant should mail or deliver the application to Johnson County Public Works at the address noted above. The permit fee is \$75 and should be in the form of a check made payable to Johnson County Public Works.

Driveway Restrictions: New entrances must be located in areas that do not pose traffic safety problems or restrict future road capacity. All entrances must comply with all County standards, criteria, recorded restrictions and plats. On section line roads, new driveway locations must also comply with minimum intersection spacing requirements and minimum lot frontage requirements based on the functional classification of the road. Please reference “Driveway Limitations” for more information on drives accessing section line roads. If the proposed driveway location does not meet all criteria, staff will assist in determining if an acceptable alternate location is available on the site.

Review of the Application: Upon receipt of the completed application, county staff will review the proposed entrance to assure conformance with all applicable requirements. Proposed driveway locations will be checked for required sight distance, distances from intersections and adjacent entrances, required frontage for number of driveways on the property and for adequate roadside drainage capacity.

Upon completion of review, the permit can be picked up by the applicant from Public Works or returned to the owner or contractor at the address provided on the application. Please verify that all mailing and e-mail addresses provided are correct and complete.

Location: In order to determine the exact location of the requested entrance, the applicant should *stake the location* within one day of filing Entrance Permit Application. The distance from the property line to the edge of the entrance should be at least 5 feet for residential entrances or at least 18 feet for commercial/industrial entrances.

Sight Distance: A new driveway will not be allowed at a location where the sight distance is inadequate to enter the traffic stream safely. Often sight distance problems can be eliminated by clearing vegetation along the right-of-way. All required clearing will be the responsibility of the applicant. New landscaping should be planned so that sight distance will not be obstructed as the landscaping matures.

Construction:

The Entrance Permit will include the type of culvert, size and length of culvert, and entrance surface requirements. Allowable culvert types include aluminized corrugated metal pipe or reinforced concrete pipe. The use of plastic pipe is prohibited except under special conditions where adequate cover is available and as approved by the County Engineer. Only new culverts will be allowed. Field entrances and residential entrances accessing streets with open ditches must, at a minimum, be surfaced with gravel but may be constructed with asphalt or concrete. Residential entrances accessing streets with curb and gutter must be constructed with concrete. *Commercial and industrial entrances must be constructed with asphalt or concrete if the adjacent county road is paved.*

It is the responsibility of the applicant to furnish the required materials and hire a contractor to perform the work in compliance with the Entrance Construction Specifications and other requirements furnished with the permit. In normal situations adequate instructions and drawings are provided with the permit so that the contractor can perform the work properly. If there are any questions the contractor should contact Johnson County Public Works.

Notify Public Works at least two days in advance of installing the entrance. Public Works will attempt to inspect the work while it is in progress in an effort to avoid costly repairs or reconstruction.

Grading within Right-of-Way:

For new construction, such as a new home or building, grading along the street frontage within the right-of-way is often necessary to establish positive flow in the open ditch and to provide reduced side slopes for easier maintenance. This work is typically performed by the building contractor as part of the overall site grading and/or driveway installation. However, please note that all work performed within the right-of-way must be inspected by Public Works even if all the grading is not included in the entrance permit. Please contact Public Works for a site inspection prior to beginning any work within the right-of-way. Normally we allow the slope at the back of the ditch to be reduced for easier maintenance, but we rarely allow the capacity of the ditch to be reduced through the addition of fill material.

Completion & Inspections

Due to the likelihood of damage to the entrance during the construction of homes and businesses there are two required inspections:

Initial Inspection: When culvert installation is part of the entrance permit, the initial inspection is performed after the culvert is installed. This inspection is to ensure proper location, workmanship, materials, elevation and drainage. To schedule this inspection, the applicant must notify Public Works when the entrance is constructed. If no building construction is anticipated in the near future, this will be the final inspection.

Final Inspection: If the Entrance Permit is issued in association with a building permit, prior to the request for Final Occupancy by Building Codes, the applicant must request a final inspection for the entrance installation. The final inspection will check for damage to the culvert and driveway surface, removal of all construction debris and the establishment of vegetation in all disturbed areas. All corrective actions are the responsibility of the applicant and must be completed prior to final acceptance of the entrance. Upon acceptance, Public Works will provide Building Codes a copy of the approved permit. *To avoid any potential delays in the issuance of the Occupancy Permit, please schedule the final entrance inspection far enough in advance to provide adequate time for any possible corrections or repairs needed for the entrance before the final inspection of the building.*

Enforcement:

Normally Building Codes will not issue a building permit unless Public Works has issued an entrance permit or approved the use of an existing entrance. A Certificate of Occupancy will not be issued unless Public Works has performed the final inspection and approved the entrance. Additionally, any unauthorized entrance or an entrance that has been constructed improperly can be removed by Johnson County Public Works. It is a code violation to install a new driveway without a permit and fines may be imposed.



Driveway Limitations

The Comprehensive Arterial Road Network Plan (CARNP) adopted by the Board of County Commissioners on January 7, 1999 reduces the number of driveways or streets that may be constructed along arterial roads (generally section line roads). In November 2000 these driveway limitations were incorporated into the county zoning and subdivision regulations. Driveways on residential streets inside subdivisions are not part of the CARNP, and different guidelines apply.

One focus of CARNP was to provide a safe roadway system and protect traffic capacity in order to minimize future construction costs. The number of driveways affects traffic safety, traffic capacity, and maintenance costs. CARNP addressed this issue by providing reasonable driveway restrictions along arterial roads. The number of driveways will be limited by driveway spacing requirements related to road frontage. The table below indicates the maximum number of driveways that your property may have based on the road frontage. Sight distance, drainage and other factors may reduce the available driveway locations. Also, there may be deed restrictions, or restrictions on the subdivision plat which may limit driveway numbers and locations.

Please keep in mind that you may want to split your property at a later date. If all available driveways are used on one portion of your property, the new owner may not be eligible for a driveway on the new tract unless you remove an existing driveway. Shared driveways are also an option in areas where there is not sufficient frontage.

Section Line and Other Arterial Roads			
<i>Required Road Frontage</i>			
<i>Roadway Type</i>	<i>No Driveway*</i>	<i>1 Driveways</i>	<i>2 Driveways</i>
<i>Type I</i>	<i>Less than 400</i>	<i>400-799</i>	<i>800-1200</i>
<i>Type II</i>	<i>Less than 660</i>	<i>660-1319</i>	<i>1320-1979</i>
<i>Type III</i>	<i>Less than 1000</i>	<i>1000-1999</i>	<i>2000-2999</i>

Corner lots with less than required frontage are restricted to access on the side road. Driveway corner clearance at the intersection of two arterial roads is 600 ft.

Entrance Construction Specifications

1. **Materials & Work:** All work and materials shall be in accordance with the approved entrance permit and any attached drawings. Check to see that pipe is the size and type specified on entrance permit. Manufactured coupling bands are required to join sections of the culvert pipe.
2. **One Call:** If any excavation is required notify **Kansas One-Call at 811** at least three (3) days in advance to have buried utilities flagged.
3. **Notification:** Notify Johnson County Public Works office one (1) day in advance of actual work, phone (913) 715-8363 or (913) 715-8300.
4. **Traffic Control:** Place warning signs prior to beginning work. Flagmen may be necessary if one lane of the road will be blocked. Traffic control shall conform to the MUTCD.
5. **Ditch Excavation:** Excavate ditch if necessary to provide proper cover over top of pipe and proper location from road. Pipe should be placed well off the shoulder to insure proper slope off the shoulder. In some rural areas, especially on gravel roads, the ditches are shallow, and it may be necessary to transition or deepen the ditch upstream and downstream hundreds of feet in order to set the pipe low enough to provide proper cover.
6. **Cover:** Minimum of 9" of cover is required over the top of RCP or CMP pipe. This 9" includes any rock surfacing and paving. If Plastic Pipe is allowed, cover must meet manufacturer's specifications. To check for minimum cover, set a level on the shoulder of the road and measure down to top of pipe.
7. **Setting Pipe:** String line flow line to insure pipe will rest on bottom for full length. Also check that there is fall in the pipe in the direction water will flow, 3" drop from end to end is the minimum.
8. **Location from road:** Place pipe in line with center of the road ditch to eliminate any sharp turns in the flow of the water. If necessary to get a reasonable slope from the road the pipe should be set back farther than the center of the ditch and then slope the inlet and outlet of the ditch for pleasing appearance.
9. **Crushed rock backfill:** AB-3 backfill is required for all installations. Tamp all backfill material. Take special care around pipe to tamp material under the haunches of pipe. To prevent erosion, the outside two (2) feet of fill at each end of the pipe shall be dirt instead of rock.
10. **Surfacing:** Cover entrance with at least 6 inches of crushed rock. (Asphalt or Concrete may be required, check the surfacing requirement on the entrance permit). If asphalt or concrete is used for driveway surfacing adjacent to a gravel road, stop the surfacing two feet short of road shoulder to prevent interference with snow plows and graders. If concrete is used for driveway surfacing adjacent to a paved road, saw cut a neat line at the edge of the existing asphalt and make sure that the concrete is not higher than the road surface. Do not place asphalt or concrete until the pipe installation has been inspected and approved. Concrete forms must be inspected by Public Works prior to pouring concrete.
11. **Cleanup:** Clean up the site and dispose of all surplus material. Smooth down areas and pick up loose rock. Notify Public Works office to obtain inspections.
12. **Curb & Gutter:** If curb & gutter is being installed on the driveway and there is no curb is on the main road then stop the curb at the back of the ditch, and let the water flow down the backslope toward the ends of the culvert, some erosion control may be necessary.

U.S. POSTAL SERVICE AND MAILBOX GUIDELINES

U.S. Postal Service Guidance

For more details on U.S. Postal Service requirements on mailboxes refer to their *Domestic Mail Manual* (DMM), specifically 508 Recipient Services: Customer Mail Receptacles <http://pe.usps.com/text/dmm300/508.htm#1051804>, as well as USPSSTD-7B Mailboxes-Residential Mailbox Standards <https://www.usps.com/manage/mailboxes.htm>, and Notice 209 <http://uspsnotices.lettercarriernetwerk.info/not209.pdf>.

Mailbox Guidelines

This section provides County's guidelines for mailboxes and newspaper delivery boxes on public right-of-ways.

Scope

No mailbox or newspaper delivery box, hereinafter referred to as mailbox, will be allowed to exist on the County's right-of-ways if it interferes with the safety of the traveling public or the function, maintenance or operation of the road system. A mailbox installation not conforming to the provisions of this regulation is an unauthorized encroachment under Kansas State Statute Section 68-545.

Mailboxes supported by structures such as masonry columns, railroad rails and ties, tractor wheels, plow blades, and concrete-filled barrels are roadside hazards that will need to be removed at the postal patron's expense.

The location and construction of mailboxes shall conform to the rules and regulations of the U.S. Postal Service as well as to standards established by the County. A mailbox installation that conforms to the following criteria will be considered acceptable unless, in the judgment of the County Engineer the installation interferes with the safety of the traveling public or the function, maintenance, or operation of the road system.

Location

No mailbox will be permitted where access is obtained from a freeway or where access is otherwise prohibited by law or regulation. Mailboxes shall be located on the right-hand side of the roadway in the carrier's direction of travel route except on one-way streets, where they may be placed on the left-hand side. The bottom of the box shall be set at a height established by the U.S. Postal Service, usually between 39 in. and 48 in. above the roadway surface. The roadside face of the box shall be offset from the edge of the traveled way a distance no less than the greater of the following:

- 8ft (where no paved shoulder exists and shoulder cross slope is 13 percent or flatter), or
- the width of the all-weather shoulder present plus 8 in. to 12 in., or
- the width of an all-weather turnout specified by the County plus 8 in. to 12 in..

Exceptions to these placement criteria will exist on residential streets and certain designated rural roads where the County deems it in the public interest to permit lesser clearances or to require greater clearances. On curbed streets, the roadside face of the mailbox shall be set back from the face of the curb at a distance of between 6 in. and 12 in. On residential streets without curbs or all-weather shoulders that carry low traffic volumes operating at low speeds, the roadside face of the mailbox shall be offset between 8 in. and 12 in. behind the edge of the pavement. On very low-volume rural roads with low operating speeds, the County may find it acceptable to offset mailboxes a minimum of 6 ft. from the traveled way and under some low volume low-speed conditions may accept clearances as low as 32 in..

- Where a mailbox is located at a driveway entrance, it shall be placed on the far side of the driveway in the carrier's direction of travel.
- Where a mailbox is located at an intersecting road, it shall be located a minimum of 100 ft. beyond the center of the intersection road in the carrier's direction of travel. This distance shall be increased to 200ft when the average daily traffic on the intersection road exceeds 400 vehicles per day.
- When a mailbox is installed in the vicinity of an existing guardrail, it should, when practical, be placed behind the guardrail.

Structure

Design and/or location criteria for the mailbox support structure should consist of the following:

- Mailboxes shall be of light sheet metal or plastic construction conforming to the requirements of the U.S. Postal Service. Newspaper delivery boxes shall be of light metal or plastic construction of minimum dimensions suitable for holding a newspaper.

- No more than two mailboxes may be mounted on a support structure unless crash tests have shown the support structure and mailbox arrangement to be safe. However, light-weight newspaper boxes may be mounted below the mailbox on the side of the mailbox support.
- Mailbox supports shall not be set in concrete unless crash tests have shown the support design to be safe.
- A single 4-in.-by-4-in. square or 4-in. diameter wooden post; or metal post, Schedule 40, 2 in. (normal size IPS (external diameter 2 $\frac{3}{8}$ in.)) (wall thickness 0.154 in. or smaller), embedded no more 24 in. into the ground, shall be acceptable as a mailbox support. A metal post shall not be fitted with an anchor plate, but it may have an anti-twist device that extends no more than 10 in. below the ground surface.
- The post-to-box attachment details should be of sufficient strength to prevent the box from separating from the post top if the installation is struck by a vehicle. The exact support hardware dimension and design may vary such as having a two-piece platform bracket or alternative slot-and-bole locations. The product must result in a satisfactory attachment of the mailbox to the post, and all components must fit together properly.
- The minimum spacing between the centers of support posts shall be the height of the posts above the ground line. Mailbox support designs not described in this regulation are acceptable if approved by the County Engineer.
- Where snow plowing operations cause damage to fixed mailbox installations, swing-away designs may be used.

Shoulder and Parking Area Construction

It shall be the responsibility of the postal patron to inform the County of any new or existing mailbox installations where shoulder construction is inadequate to permit all-weather vehicular access to the mailbox.

Removal of Nonconforming or Unsafe Mailboxes

Any mailbox that is found to violate the intent of these guidelines shall be removed by the postal patron upon notification by the County. At the discretion of the County, based on an assessment of hazard to the public, the patron shall be granted not less than 24 hours and no more than 30 days to remove an unacceptable mailbox. After the specified period has expired, the unacceptable mailbox will be removed by the County at the postal patron's expense.

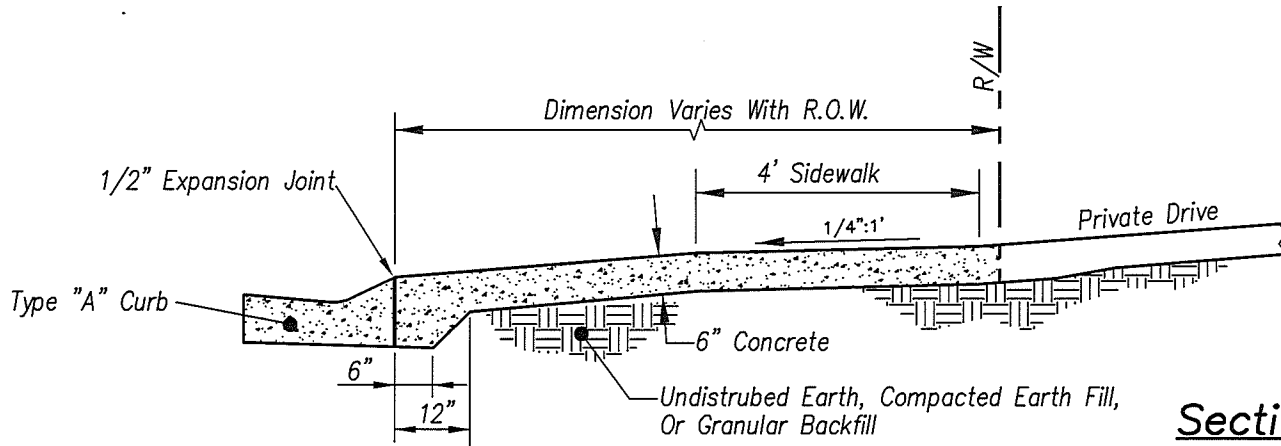

Section A-A
No Scale

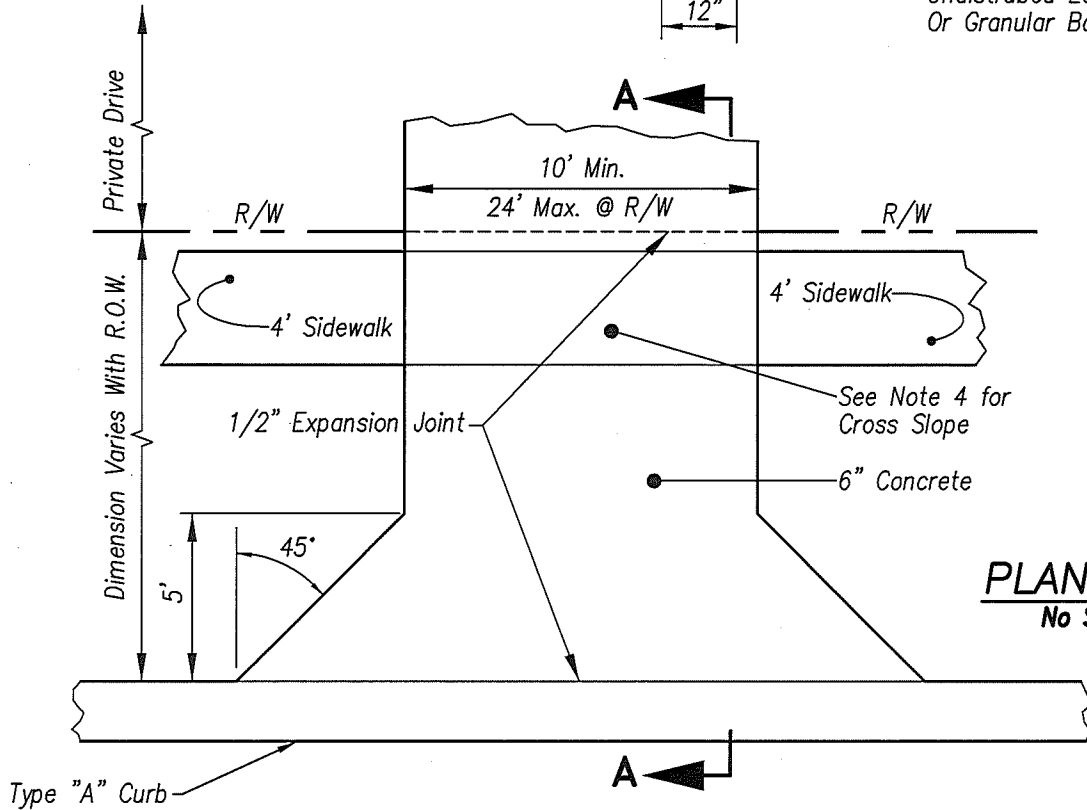

PLAN VIEW
No Scale

NOTES:

1. Cut or saw contraction Joints @ 12' (Max.) each direction.
2. Inspection of driveway forms is required prior to paving.
3. Concrete shall be 4,000 P.S.I. with A.E.
4. Thru sidewalk area, maintain 1/4" /ft. sidewalk cross slope for ADA compliance.

**RESIDENTIAL ENTRANCE
WITH TYPE "A" CURB**

Dwg. 10

Johnson County, Kansas

Approved by:

Mac Andrew

Mac Andrew, P.E.
County Engineer

Date Current Rev. November 2009

NOTES:

1. Inspection of driveway forms is required prior to paving.
2. If R/W line is lower than top of curb, driveway shall be constructed to Type "B" curb height @ 5' back of curb and slope downward to the R/W line.
3. Concrete shall be 4,000 psi with AE.
4. Cut or saw contraction joints @ 12' (Max.) each direction.
5. Thru sidewalk area, maintain 1/4"/Ft. cross slope for ADA compliance.

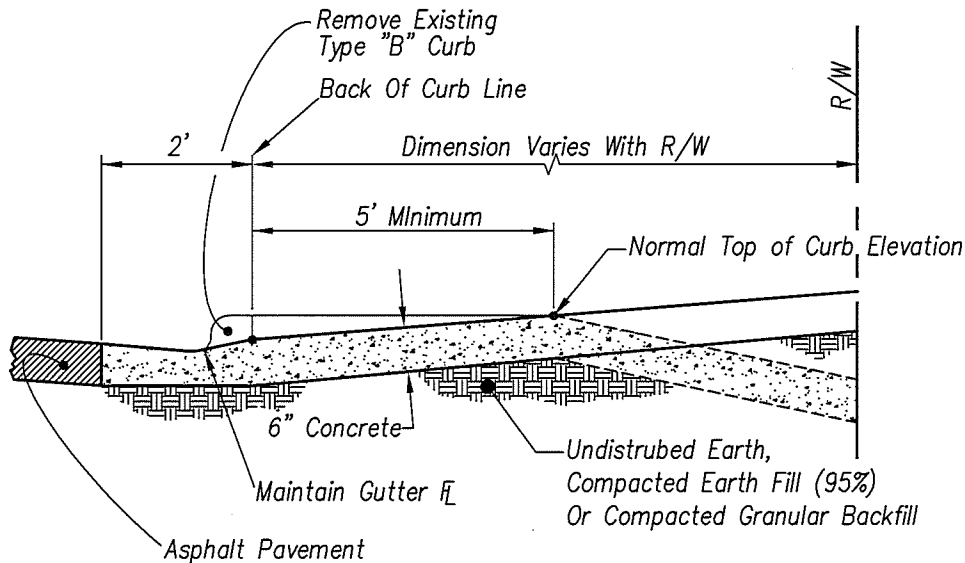

Section A-A
No Scale

**RESIDENTIAL ENTRANCE
WITH TYPE "B" CURB**

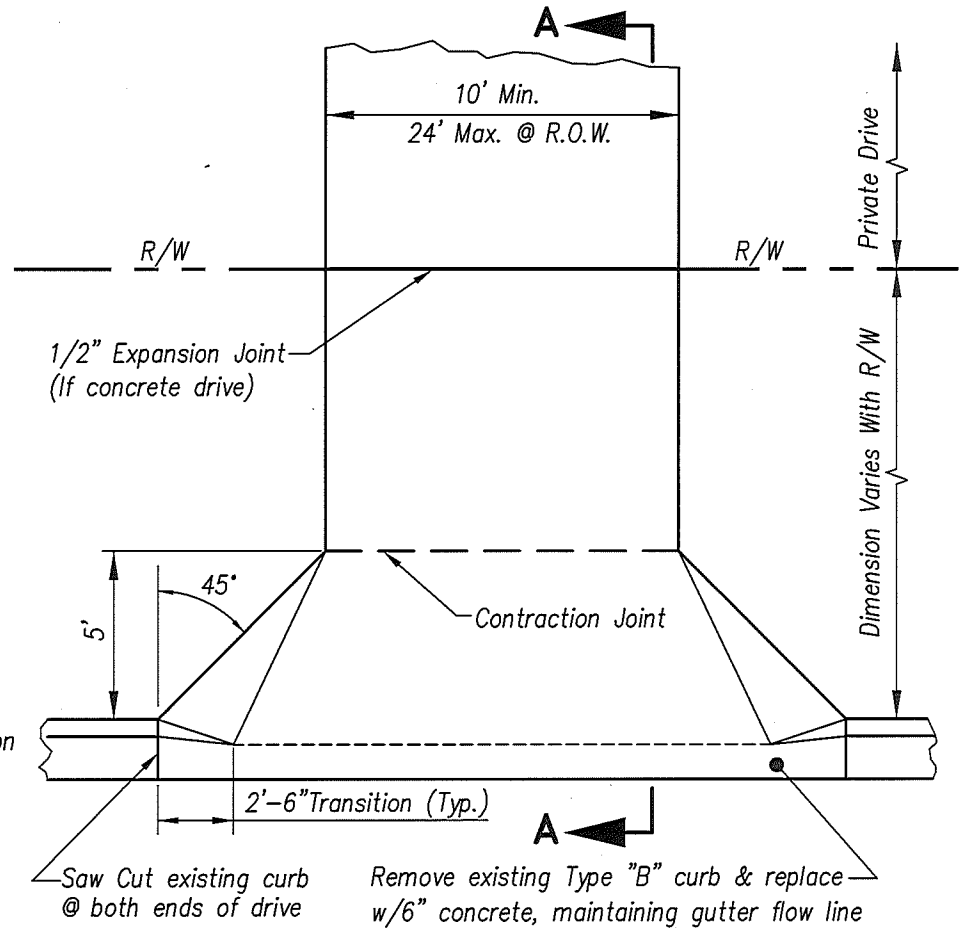

PLAN VIEW
No Scale

Dwg. 11

Johnson County, Kansas

Approved by:

Mac Andrew

Mac Andrew, P.E.
County Engineer

Date _____ Current Rev. November 2009

NOTES:

1. Culvert diameter to be approved by the Public Works Department.
2. Minimum length culvert shall comply with drive elevation view.
3. Culvert shall be 16 ga. C.M.P. or R.C.P. with 6' (Min.) length joints, or A.D.S. N-12.
4. Manufactured coupling bands are required with C.M.P. and A.D.S. pipe.
5. Inspection of driveway forms is required prior to pouring of concrete.
6. Concrete shall be 4,000 P.S.I. with A.E. Cut or saw contraction joints @ 12' (Max.) each direction.
7. Compacted granular backfill is required with A.D.S. N-12 pipe.
8. A.D.S. N-12 Pipe allowed only with 12" minimum cover, and only if approved by the Public Works Department.
9. Concrete to be set back a minimum of 2' from the edge of roadway transition installed by Public Works.
10. Top of concrete to be level with road surface.
11. Ditch needs to be cleaned both upstream and downstream for correct flow thru culvert.

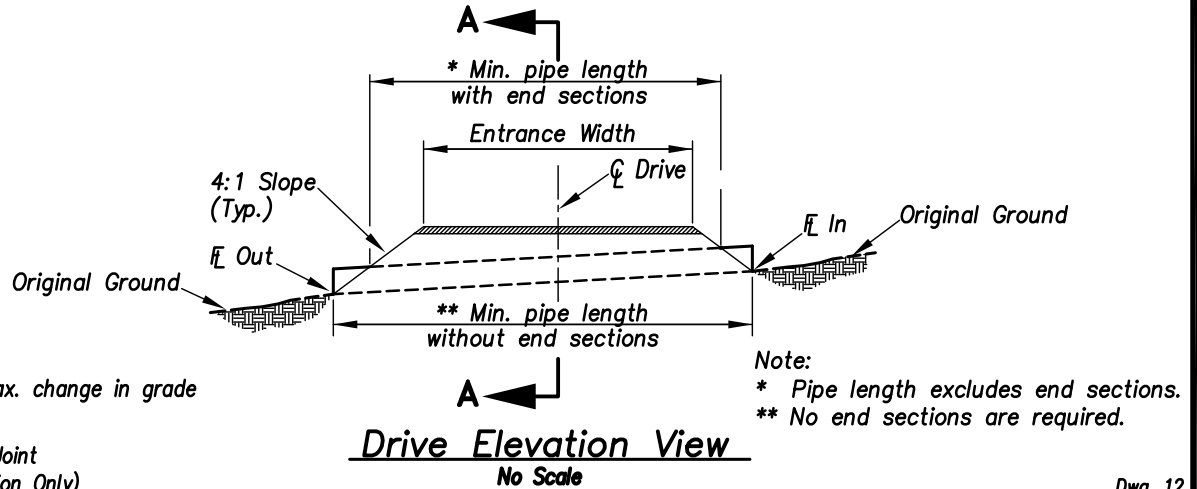
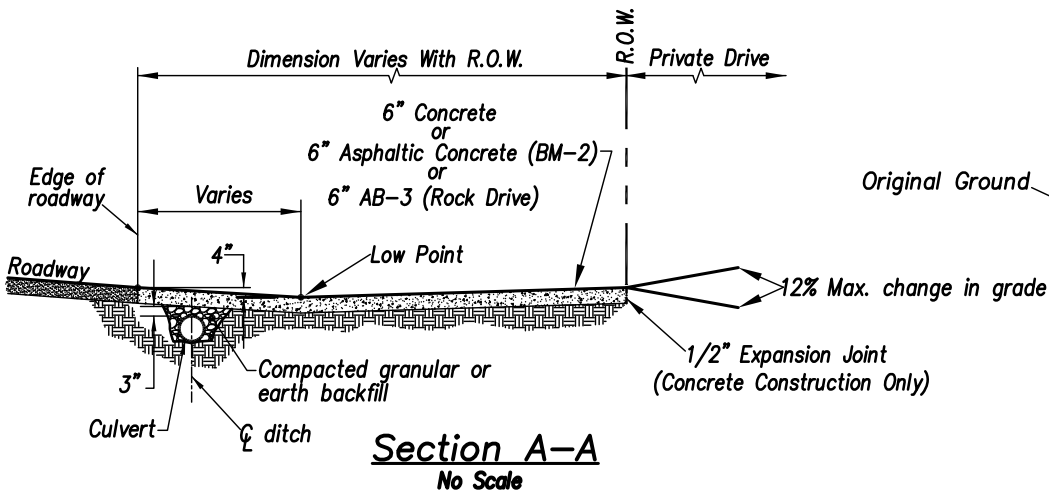
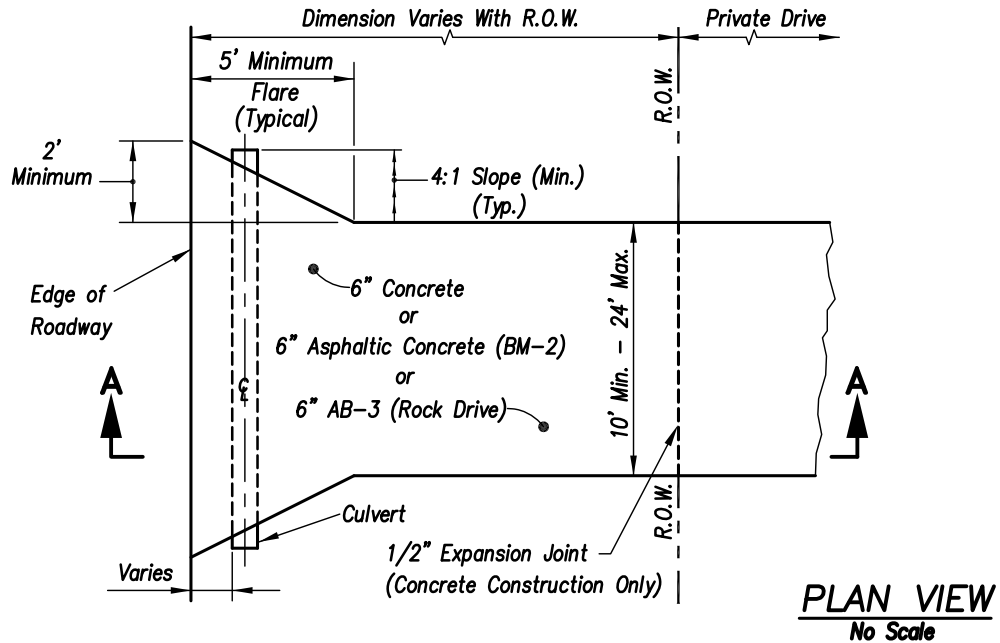

RESIDENTIAL & FIELD ENTRANCE WITH DITCH

Johnson County, Kansas

Approved by:

Mac Andrew

Mac Andrew, P.E.
County Engineer

Date Current Rev. November 2009

NOTES:

1. Type "B" curb may be tapered from full curb to nothing @ right-of-way.
2. Cut or saw construction joints @ 12' (max.) each direction.
3. Inspection of driveway forms is required prior to paving.
4. 6" minimum height above top of curb may vary higher from prior Public Works approval, but must not exceed 9" above top of curb.
5. Concrete shall be KCMMB 4K on R/W.
6. The driveway shall be constructed to Type "B" curb height @ 6' back of curb if R/W elevation is lower than top of curb.
7. Thru sidewalk area, maintain 1/4"/Ft. cross slope for ADA compliance.

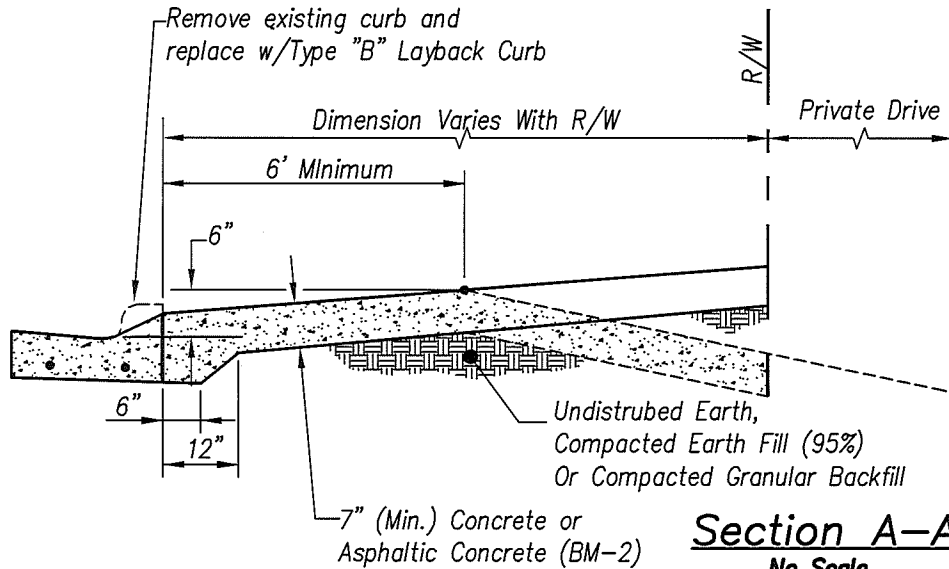

**COMMERCIAL/INDUSTRIAL
ENTRANCE WITH CURBS**

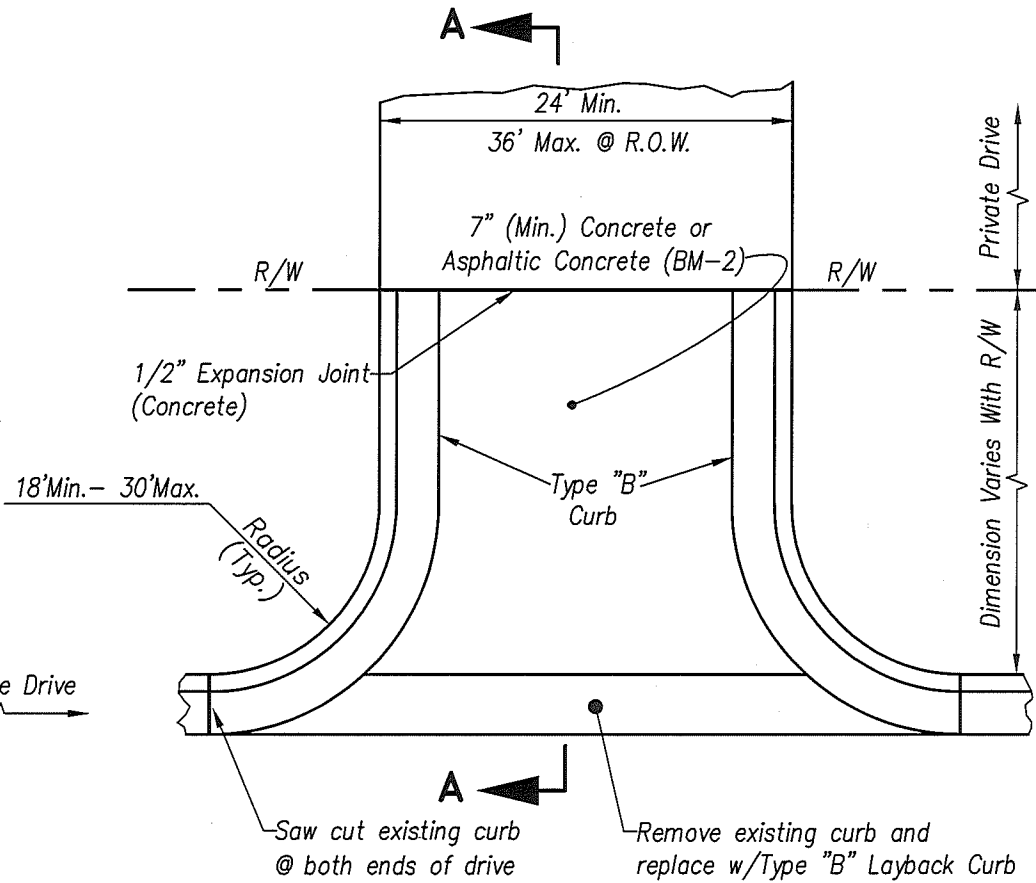

Dwg. 13

Johnson County, Kansas

Approved by:

Mac Andrew
Mac Andrew, P.E.
County Engineer

Date Current Rev. November 2009

NOTES:

1. Culvert diameter to be approved by the Public Works Department.
2. Minimum length culvert comply with drive elevation view.
(See Entrance Permit).
3. Culvert shall be 16 ga. C.M.P. or R.C.P. with 6' (Min.) length joints.
4. Manufactured coupling bands are required with C.M.P. Pipe.
5. Inspection of driveway forms is required prior to pouring of concrete.
6. Concrete shall be KCMMB 4K on R/W. Cut or saw contraction joints @ 12' (Max.) each direction.
7. Compacted granular backfill is required under concrete and asphalt surfacing.
8. If a gravel surface is allowed, then an 8" thickness of AB-3 is required.
9. Concrete to be set back a minimum of 2' from the edge of roadway transition installed by Public Works.
10. Top of concrete to be level with road surface.
11. Curbs not to extend past edge of ditch.

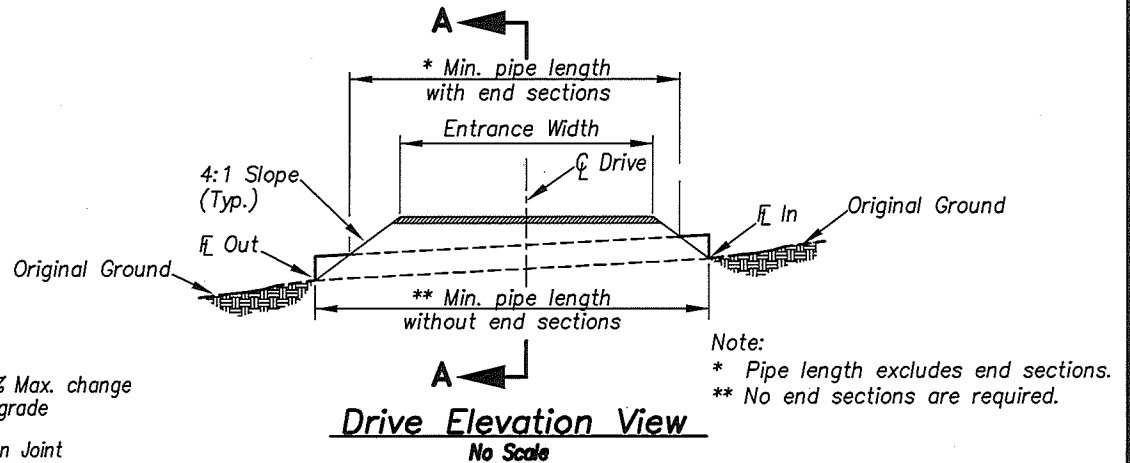
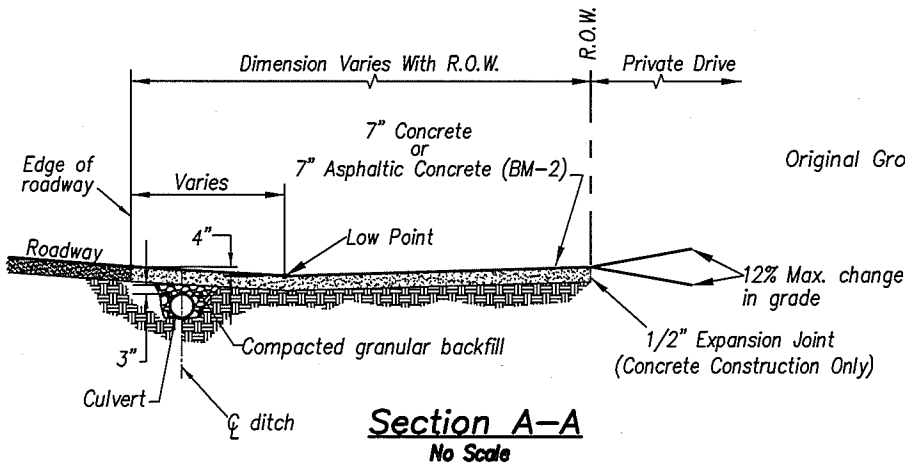
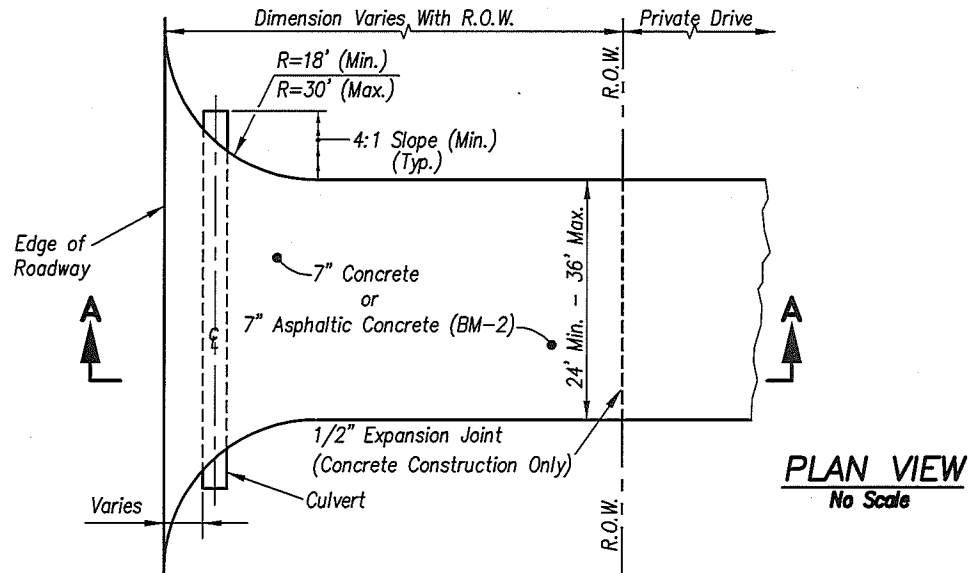

Dwg. 14

COMMERCIAL/INDUSTRIAL ENTRANCE WITH DITCH

Johnson County, Kansas	
Approved by:	
Mac Andrew, P.E. County Engineer	
Date _____ Current Rev. November 2009	